

# **SECTION 10**

	Emergya Wind Technologies BV
	DIRECTWIND 52/54

Category:	Specification	Page 1 / 18
Doc code:	S-1000910.docx	

Created by:	BH	Creation Date:	08-07-09
Checked by:	TY	Checked Date:	08-07-09
Approved by:	OEL	Approved Date:	08-07-09

<p>Title:</p> <p style="text-align: center;">Specification</p> <p style="text-align: center;"><b>Transport, storage and crane guidelines</b></p>
--

Revision	Date	Author	Approved	Description of changes
04	17-11-11	FD	WR	Added anchors, changed tower dimensions
03	23-09-11	WR	NC	Added crane hard stand and changed info
02	26-08-10	WR	TY	added transport and crane drawings
01	11-12-09	TY	OEL	Added 35 m Tower
-	-	-	-	-
-	-	-	-	-

<p>Emergya Wind Technologies BV</p> <p>Building "Le Soleil" - Computerweg 1 - 3821 AA Amersfoort - The Netherlands</p> <p>T +31 (0)33 454 0520 - F +31 (0)33 456 3092 - www.ewtinternational.com</p>
--

<p>© Copyright Emergya Wind Technologies BV, The Netherlands. Reproduction and/or disclosure to third parties of this document or any part thereof, or use of any information contained therein for purposes other than provided for by this document, is not permitted, except with the prior and express permission of Emergya Wind Technologies BV, The Netherlands.</p>
---

	Category:	Specification	08-07-09
	Title:	Transport, storage and crane guidelines	Page 2 / 18
	Doc code:	S-1000910.docx	

## Contents

1	<b>Introduction</b>	3
2	<b>Tower</b>	4
3	<b>Nacelle</b>	6
4	<b>Hub</b>	6
5	<b>Generator</b>	7
6	<b>Blades</b>	7
7	<b>Miscellaneous components</b>	8
8	<b>Cranes</b>	8
8.1	Example of Site layout / Crane plan	10
9	<b>Roads and crane hard stand</b>	11
9.1	Example of road construction	12
10	<b>Overview of transport vehicles examples</b>	13
11	<b>Overview handling examples</b>	15
11.1	Tower handling	15
11.2	Blade handling	16
11.3	Generator handling	17
11.4	Nacelle and hub handling	18

	Category:	Specification	08-07-09
	Title:	Transport, storage and crane guidelines	Page 3 / 18
	Doc code:	S-1000910.docx	

## 1 Introduction

The information contained in this Guideline is for the purpose of determining the requirements needed for transport, handling, storage and lifting of the DIRECTWIND S2 and S4 wind turbine building blocks.

In each of the following chapters the dimensions and weight of the building blocks is listed.

For some of the building blocks special equipment/tools are available for transport and lifting purposes.

Depending on the means of transport agreed, the requirements for the access- and service roads to and on the site can be determined. If the requirements mentioned in this document cannot be adhered to, EWT should be consulted in advance of the proceeding.

The information contained in this guideline does not intend to be complete and in case of any doubt or questions EWT should be contacted.

When using special transport vehicles, cranes and lifting equipment, these should be certified as required by the Authorities in the country of use.

	Category:	Specification	08-07-09
	Title:	Transport, storage and crane guidelines	Page 4 / 18
	Doc code:	S-1000910.docx	

## 2 Tower

The tower comprises of 2 or 3 sections, depending on the height of the tower.

Tower 75, 50, 40 and 35 m Hub Height				
<b>Hub Height 75 m</b>	<b>Tower height 70.5 m (nominal)</b>			
	Dimensions			Weight {ton}
	Max diam. [m]	Min diam. [m]	Length [m]	
Top section	2.53	1.92	23.75	16.0
Middle section	3.14	2.53	23.05	23.5
Bottom section	3.96	3.14	23.70	47.0
<b>Hub Height 50 m</b>	<b>Tower height 46.4 m (nominal)</b>			
	Dimensions			Weight {ton}
	Max diam. [m]	Min diam. [m]	Length [m]	
Top section	2.76	1.92	23.23	15.5
Bottom section	3.60	2.76	23.20	30.5
<b>Hub Height 40 m</b>	<b>Tower height 36.4 m (nominal)</b>			
	Dimensions			Weight {ton}
	Max diam. [m]	Min diam. [m]	Length [m]	
Top section	2.76	1.92	23.22	15.4
Bottom section	3.60	2.76	13.20	16.5
<b>Hub Height 35 m</b>	<b>Tower height 30.5 m (nominal)</b>			
	Dimensions			Weight {ton}
	Max diam. [m]	Min diam. [m]	Length [m]	
Top section	2.76	1.92	15.28	10.0
Bottom section	3.60	2.76	15.25	18.3
Lifting	The tower sections should be lifted using special lifting tools (such as swivels). In case no swivels, but slings are used, precautions are to be taken to avoid damage to the tower surface (conservation).			
Storage	Tower sections need to be covered with tarpaulins at both ends during transport and storage, to eliminate dust and dirt getting inside the tower.			
Transport	For transport standard truck and trailer combinations can be used. Tower sections need to be covered with tarpaulins at both ends during transport and storage, to eliminate dust and dirt getting inside the tower.			

	Category:	Specification	08-07-09
	Title:	Transport, storage and crane guidelines	Page 5 / 18
	Doc code:	S-1000910.docx	

### Tube anchor 3600 mm Diameter for 35, 40 and 50m hh towers

	Dimensions			Weight [ton]
	Diameter top (m)	Diameter bottom (m)	Height (m)	
<b>Dimensions</b>	3.60	3.72	1.53	3.7
Lifting	The anchor should be lifted by using suitable lifting eyes that are belted to the anchor before the lift.			
Storage				
Transport	Typically the anchor is placed in a horizontal position on the trailer during transport. When the anchor is transported on a suitable trailer in vertical position then the width will be reduced for transport as an alternative when required.			

### Cage anchor 3960 mm Diameter

	Dimensions			Weight [ton]
	Diameter top (m)	Diameter bottom (m)	Height (m)	
<b>Dimensions</b>	3.96	3.92	var	3.0
Lifting	Slings to be used to lift the parts			
Storage				
Transport	Typically the anchor is placed in a horizontal position on the trailer during transport. The anchor will be in two halves during transportation.			

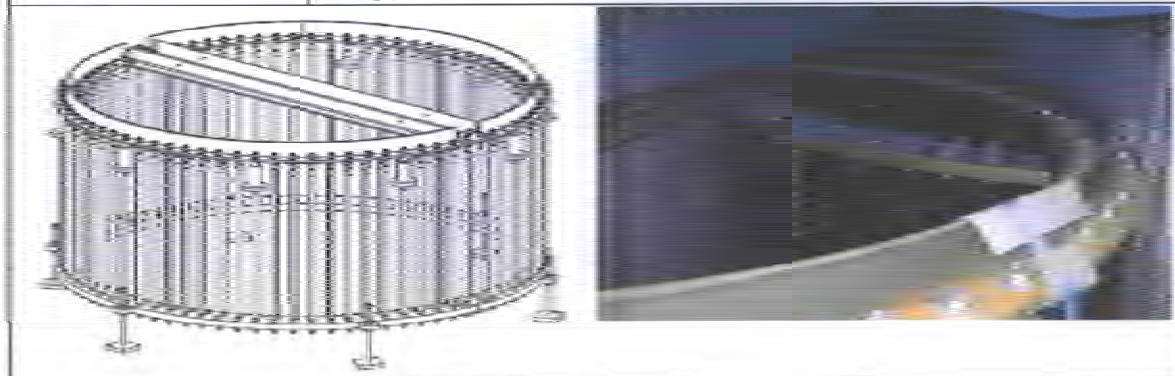

	Category:	Specification	08-07-09
	Title:	Transport, storage and crane guidelines	Page 6 / 18
	Doc code:	S-1000910.docx	

### 3 Nacelle

Nacelle				
	Dimensions			Weight [ton]
	Length [m]	Width [m]	Height [m]	
Nacelle, assembled incl. transport/support frame	5,2	2,58	2,22	10,0
Lifting	The nacelle should be lifted using special lifting tools. In case slings are used, precautions are to be taken to avoid damage to the nacelle surface (conservation).			
Storage	When storing the nacelle, this should be in a dry place. The nacelle should be covered with tarpaulins or cling-film during storage, to eliminate dust and dirt getting inside the nacelle.			
Transport	Typically the nacelle is placed on a flat-rack. In case transport is over sea, the packing needs to be seaworthy, including dehumidifying materials. All openings are to be sealed to prevent dust and dirt entering the nacelle.			

### 4 Hub

Hub				
	Dimensions			Weight [ton]
	Diameter [m]		Height [m]	
Hub	3,00		2,50	9,2
Lifting	The hub should be lifted using the eye bolts provided.			
Storage	When storing the hub, this should be in a dry place. In case of high humidity, dehumidifying materials should be included. All openings are to be sealed to prevent dust and dirt entering the hub. The hub should be stored on wood to avoid damage to the flange.			
Transport	Typically the hub is placed on a flat-rack. In case transport is over sea, the packing is to be seaworthy, including dehumidifying materials. All openings are to be sealed to prevent dust and dirt entering the hub.			

	Category:	Specification	08-07-09
	Title:	Transport, storage and crane guidelines	Page 7 / 18
	Doc code:	S-1000910.docx	

## 5 Generator

Generator				
	Dimensions			Weight [ton]
	Diameter [m]		Height [m]	
Generator	5.7		2.8	32.0
Lifting	The generator should be lifted using special lifting frame supplied by EWT.			
Storage	When storing the generator, this should be in a dry place. In case of high humidity, dehumidifying materials should be included.			
Transportation	Typically the generator is packed on a flat-rack. In case transport is overseas, the packing is seaworthy.			

## 6 Blades

Blades 24.5 and 25.8 m				
	Dimensions			Weight [ton]
	Length [m]	Width [m]	Height [m]	
PMC 25.8 - Set of 3 Blades including transport frames	26.2	1.35/ 2.55	3.1	Approx. 2.5/ 10
PMC 24.5 - Set of 3 Blades including transport frames	24.9	1.35/ 2.55	3.1	Approx. 2.2/ 9.5
Lifting	Single blade: using a small crane and sling of at least 200mm wide. Set of 3 blades: set is packed in a frame (used for overseas transportation). Lifting only by the frames. Single blades to be lifted using slings.			
Storage	Use the special blade stands or frames provided.			
Transportation	In case transport is overseas, the blades are fitted with transport frames and grouped in sets of 3 blades. In case transport is overseas, the packing is seaworthy. For road transport blades can be supported by special supports at root end and 5-7m from tip end.			



	Category:	Specification	08-07-09
	Title:	Transport, storage and crane guidelines	Page 8 / 18
	Doc code:	S-1000910.docx	

## 7 Miscellaneous components

### Converter and other small components

Lifting	The converter should be lifted using a forklift or when lifted by a crane the slings should be fed through the pallet
Storage	When storing the converter, this should be in a dry place. In case of high humidity, dehumidifying materials should be included.
Transportation	Typically the converter is packed on a pallet. The converter is then standing vertically and care should be taken when securing this load against overturning during transport. In case transport is overseas, the packing is to be seaworthy.

In addition to the converter other small parts and components (such as bolts, nuts, washers, ladder-steps and lifting equipment and a tool container) will have to be packaged and transported to the site, typically in a 20ft container with a total weight of about 7 ton. Packaging and logistics of these components will be project specific.

## 8 Cranes

### Guidelines for Tower Hub Height 75 m

<b>Main Crane</b>	
Requirements	Depending on the type of crane used the tonnage of the crane needed is between 400 to 600 metric tons. Typically the type of crane, the age of the crane and the set-up will determine what crane is suitable.
Typically used crane	Liebherr LTM 1500, Demag AC 500-1 or AC 500-2, Liebherr LTM 1650 OR Liebherr LR 1350, Demag CC 1800
<b>Tail crane</b>	
Requirements	Hydraulic crane with minimum capacity of 90 metric tons
Typically used crane	Liebherr LTM 1090
Max ground pressure	150 kN/m <sup>2</sup>

### Guidelines for Tower Hub Height 35, 40 and 50 m

<b>Main Crane</b>	
Requirements	Depending on the type of crane used the tonnage of the crane needed is between 250 to 400 metric tons. Typically the type of crane, the age of the crane and the set-up will determine what crane is suitable.
Typically used crane	Liebherr LTM 1400-5, Liebherr LTM 1300-1, Demag AC 350 OR Liebherr LR 1250, Demag CC 1500
<b>Tail crane</b>	
Requirements	Hydraulic crane with minimum capacity of 90 metric tons
Typically used crane	Liebherr LTM 1090
Max ground pressure	150 kN/m <sup>2</sup>

© Copyright Emergya Wind Technologies bv, The Netherlands. Reproduction and/or disclosure to third parties of this document or any part thereof, or use of any information contained therein for purposes other than provided for by this document, is not permitted, except with the prior and express permission of Emergya Wind Technologies BV, The Netherlands.

	Category:	Specification	08-07-09
	Title:	Transport, storage and crane guidelines	Page 9 / 18
	Doc code:	S-1000910.docx	

**IMPORTANT NOTE:**

The information above is an indication of requirements. It is the crane contractor's responsibility to perform an appropriate site survey before the works commences.

The site survey will determine exact location where the main crane and the tail crane will be placed in relation to the base of the WTG tower, the access route for the building blocks, and the construction area at the place of erection.

For each WTG a different crane plan will need to be made, as for each WTG position the soil conditions, the access route, site conditions (other obstacles), and therefore the position of cranes can be different in relation to the WTG.

It is the crane contractor's responsibility to make, on the basis of the site survey, a crane plan for each WTG location. The type of crane to be used is to be selected by the crane company and dependant on the make and the technical data.

The site survey will also determine if any civil works need to be undertaken. These civil works are not limited to flattening any (rough) surface for easy access, but may also include that the soil conditions will need to be investigated to determine the need for any additional work to be carried out (e.g. soil improvement, civil ground works, steel tracks) in order the underground can carry the loads from crane outriggers, the building blocks and the transport equipment that carry these to the place of installation and the equipment (cranes) used to do this job. The crane plan will be submitted to EWT for review. The final lay-out remains the responsibility of the crane contractor.

	Category:	Specification	08-07-09
	Title:	Transport, storage and crane guidelines	Page 10 / 18
	Doc code:	S-1000910.docx	

**8.1 Example of Site layout / Crane plan**

No worksheet with the used crane configuration and safe working 8.10 m/s

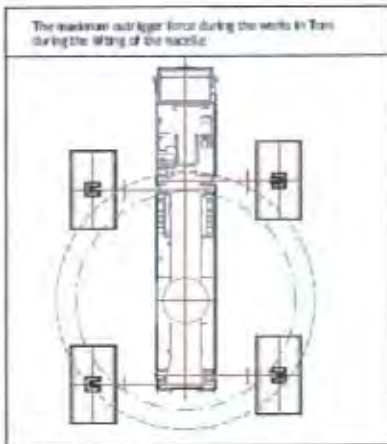

Main crane example	Settings
LTM 1400 7.1 as 300T	
Main boom	(M) 56.2+2.1
Job boom	(M) 14
Outrigger base	(M) 80 x 9.5
Counterweight	(T)
Working radius	(M)
Max. lifting capacity	(T)
Max weight load	(T)
Weight hook block	(T)
Weight Lifting Equipment	(T)
Total Weight	(T)

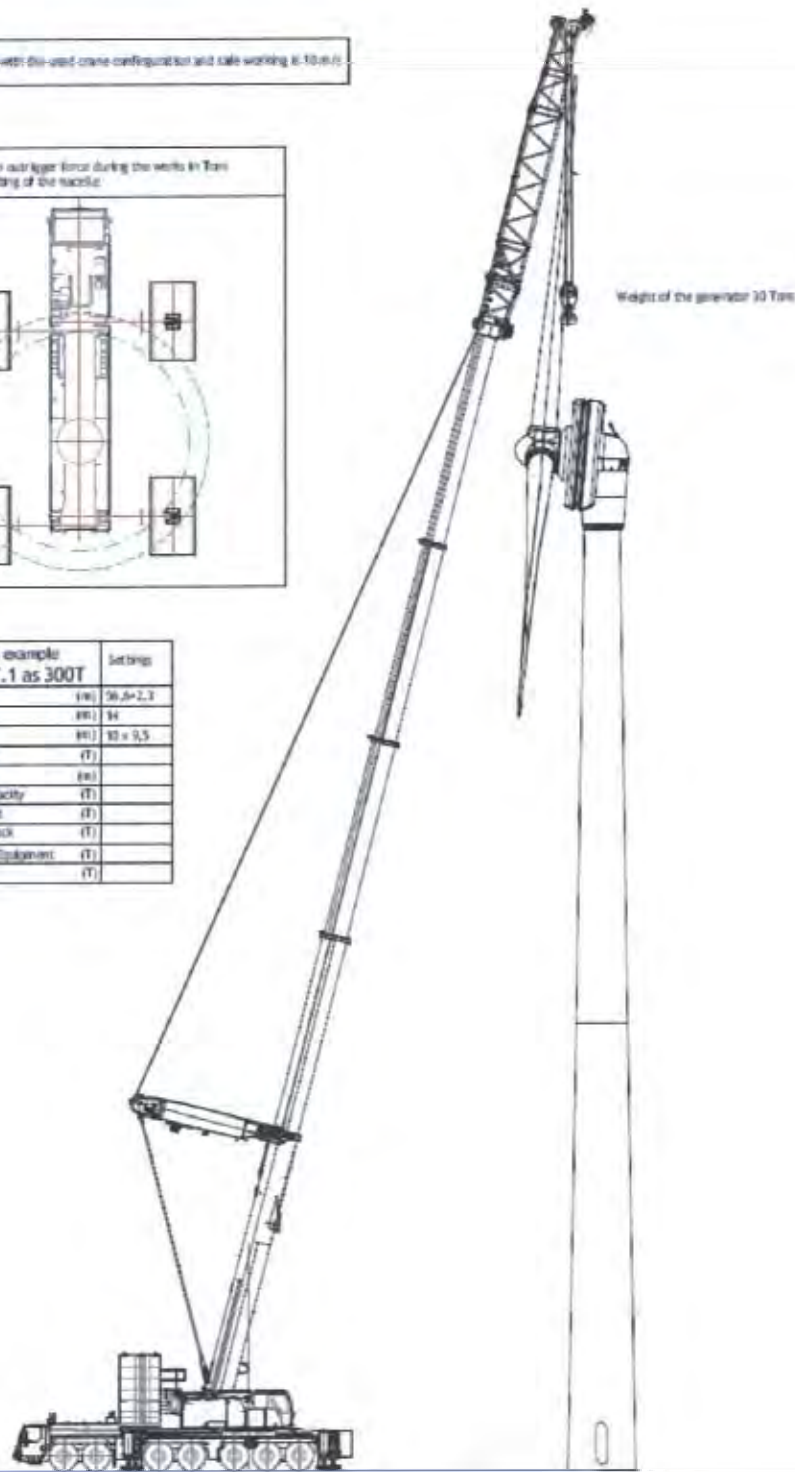

© Copyright Emergya Wind Technologies bv, The Netherlands. Reproduction and/or disclosure to third parties of this document or any part thereof, or use of any information contained therein for purposes other than provided for by this document, is not permitted, except with the prior and express permission of Emergya Wind Technologies BV, The Netherlands.

	Category:	Specification	08-07-09
	Title:	Transport, storage and crane guidelines	Page 11 / 18
	Doc code:	S-1000910.docx	

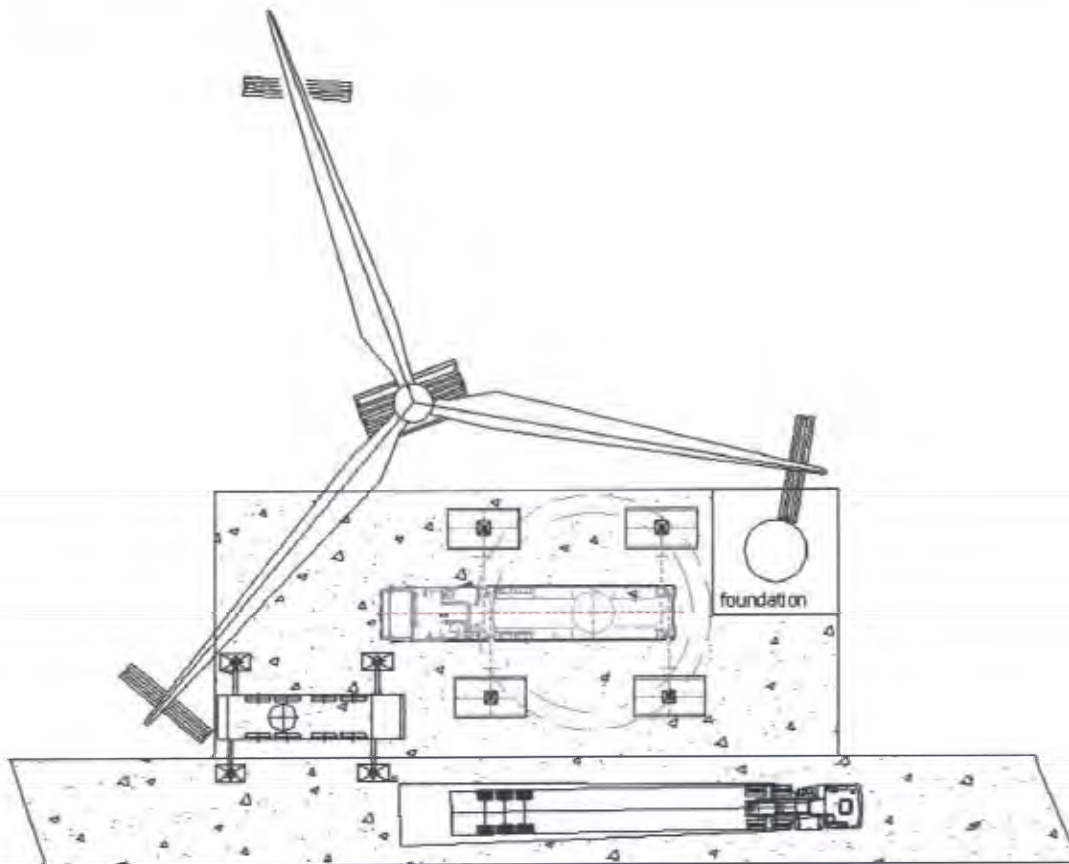

Minimum Crane hardstand/ site working area 35 x 15m

## 9 Roads and crane hard stand

Access roads, as well as the roads on site, including bridges have to be able to withstand the movement of heavy equipment and trucks with heavy exceptional cargo up to a maximum axle load of 15T and a maximum overall weight of 120T. Access has to be kept clear at all times. The EWT Project Manager has to be informed in case problems are expected.

The employer is obliged to have the permanent Crane Hard stand with ground bearing capacity of at least 150kN/ m<sup>2</sup>. Dimensions for the permanent crane hard stand are minimum 15 x 35m and connected to the turbine foundation and the access road.

© Copyright Emergya Wind Technologies bv, The Netherlands. Reproduction and/or disclosure to third parties of this document or any part thereof, or use of any information contained therein for purposes other than provided for by this document, is not permitted, except with the prior and express permission of Emergya Wind Technologies BV, The Netherlands.

	Category:	Specification	08-07-09
	Title:	Transport, storage and crane guidelines	Page 12 / 18
	Doc code:	S-1000910.docx	

### Minimum Road requirements

Useful with of carriage way	4,0m
Clearance width	5,7m
Clearance height	4,6m
Minimum Bend radius *	20m
Maximum longitudinal slope *	8 °
Maximum lateral slope *	0-2°
Maximum axle load	15T

\* Deviations To the acceptance of the Transport Company and Crane Hire Company

### 9.1 Example of road construction

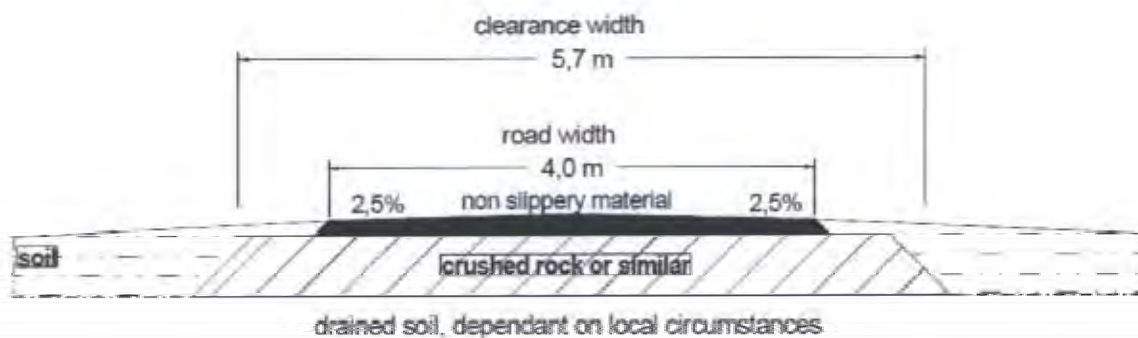

The construction illustrated above is an example, constructed on solid soil. Other circumstances might require other constructions to meet the minimum requirements, for example use more crushed rock or similar, install a geogrid or other solutions. EWT has always to be informed prior to access road construction and in case of changes to the existing situation.

The important part of access road construction is drainage and water discharge. Always prevent water to be near the access roads and construction area.

	Category:	Specification	08-07-09
	Title:	Transport, storage and crane guidelines	Page 13 / 18
	Doc code:	S-1000910.docx	

## 10 Overview of transport vehicles examples

### Tower section example

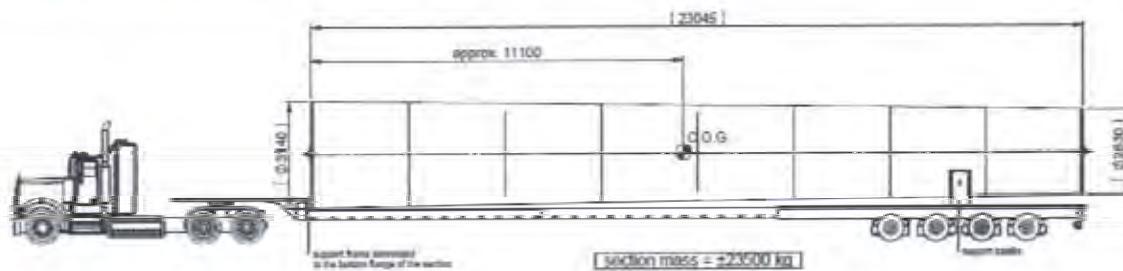

### Nacelle

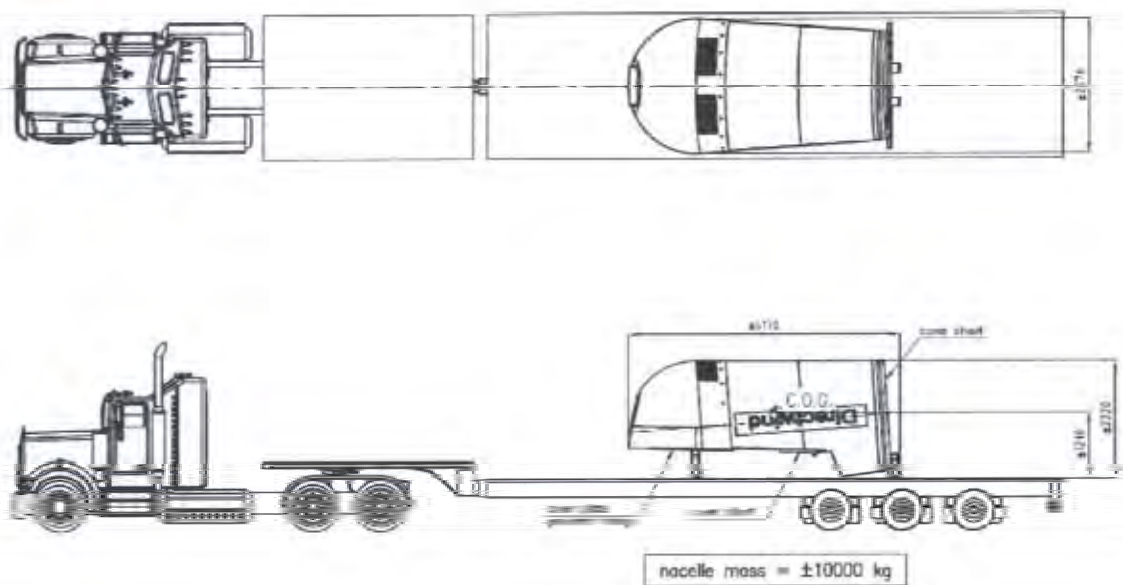

### Blades

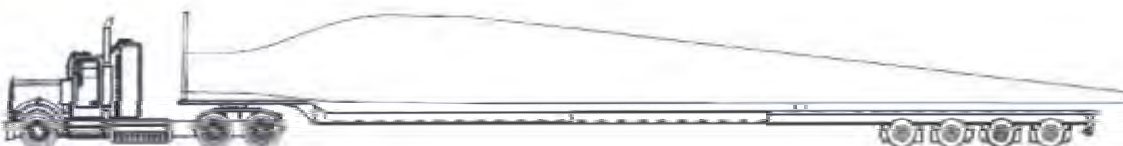

	Category:	Specification	08-07-09
	Title:	Transport, storage and crane guidelines	Page 14 / 15
	Doc code:	S-1000910.docx	

Hub

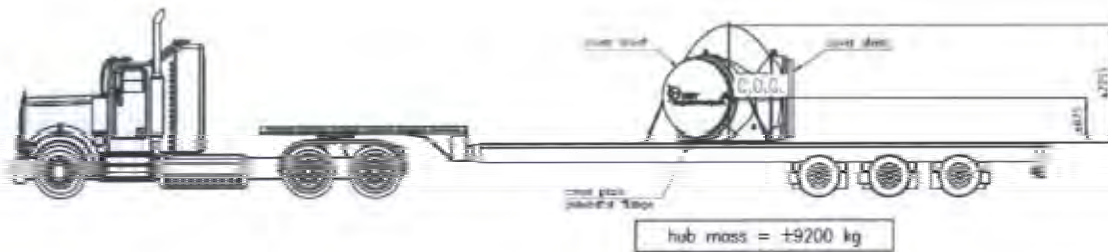
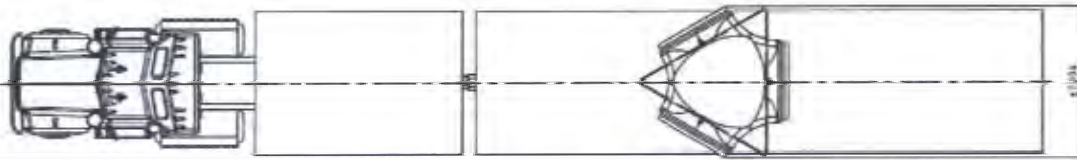

Generator

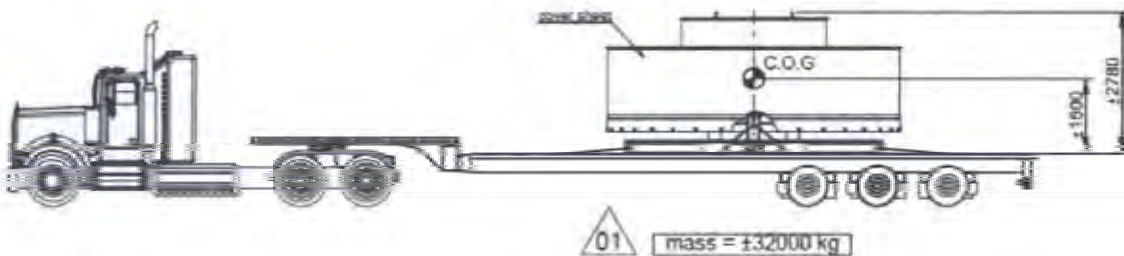
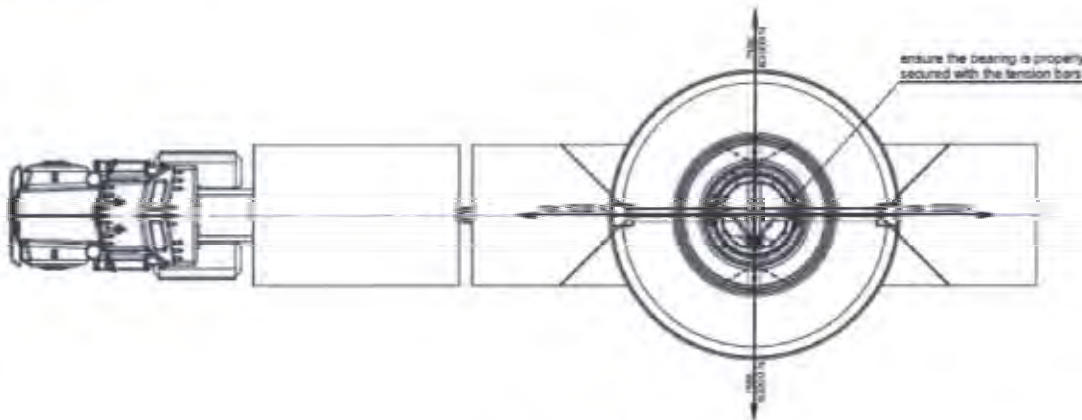

© Copyright Energya Wind Technologies Bv, The Netherlands. Reproduction and/or disclosure to third parties of this document or any part thereof, or use of any information contained therein for purposes other than provided for by this document, is not permitted, except with the prior and express permission of Energya Wind Technologies Bv, The Netherlands.

	Category:	Specification	08-07-09
	Title:	Transport, storage and crane guidelines	Page 15 / 18
	Doc code:	S-1000910.docx	

## 11 Overview handling examples

### 11.1 Tower handling



© Copyright Emergya Wind Technologies bv, The Netherlands. Reproduction and/or disclosure to third parties of this document or any part thereof, or use of any information contained therein for purposes other than provided for by this document, is not permitted, except with the prior and express permission of Emergya Wind Technologies BV, The Netherlands.



	Category:	Specification	08-07-09
	Title:	Transport, storage and crane guidelines	Page 16 / 18
	Doc code:	S-1000910.docx	

## 11.2 Blade handling



© Copyright Emergya Wind Technologies B.V., The Netherlands. Reproduction and/or disclosure to third parties of this document or any part thereof, or use of any information contained therein for purposes other than provided for by this document, is not permitted, except with the prior and express permission of Emergya Wind Technologies B.V., The Netherlands.

	Category:	Specification	08-07-09
	Title:	Transport, storage and crane guidelines	Page 17 / 18
	Doc code:	S-1000910.docx	

### 11.3 Generator handling

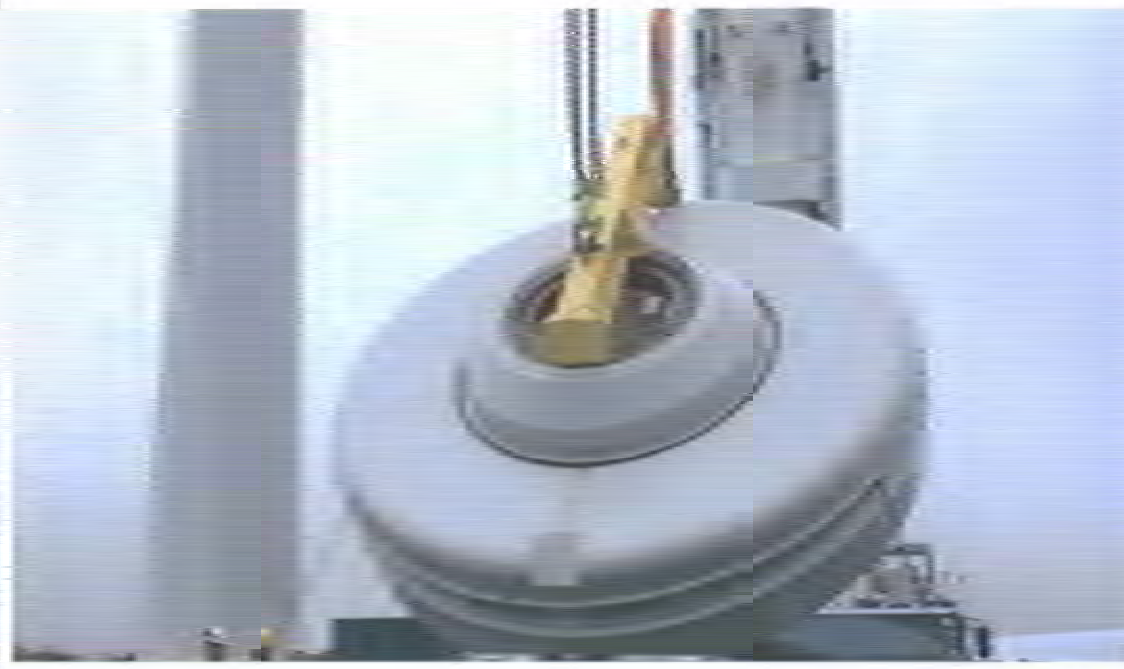

© Copyright Emergya Wind Technologies bv, The Netherlands. Reproduction and/or disclosure to third parties of this document in any part thereof, or use of any information contained therein for purposes other than provided for by this document, is not permitted, except with the prior and express permission of Emergya Wind Technologies BV, The Netherlands.

	Category:	Specification	08-07-09
	Title:	Transport, storage and crane guidelines	Page 18 / 18
	Doc code:	S-1000910.docx	

#### 11.4 Nacelle and hub handling



© Copyright Emergya Wind Technologies bv, The Netherlands. Reproduction and/or disclosure to third parties of this document or any part thereof, or use of any information contained therein for purposes other than provided for by this document, is not permitted, except with the prior and express permission of Emergya Wind Technologies BV, The Netherlands.